

SHORT FORM CATALOG INDUSTRIAL BATTERIES FOR PROFESSIONALS

FIND THE RIGHT BATTERY
FOR YOUR APPLICATION



FIND THE RIGHT PAGE



COMPANY / MARKETING
SERVICE TOOLS
PAGE 4 - 7



NICKEL-METAL HYDRIDE
PAGE 8 - 15



LITHIUM-ION PIN TYPE
PAGE 22 - 23



LITHIUM-ION
PAGE 16 - 21



LITHIUM
PAGE 24 - 39



ALKALINE
PAGE 40 - 41

ONE OF THE WORLD'S LARGEST BATTERY MANUFACTURERS

ABOUT 20,000*1



SALES: € 6.16 BILLION

OPERATING PROFITS: € 0.52 BILLION*2

*1 Employees of Panasonic Energy consolidated, as of April 1, 2022

*2 "FY2021" refers to the year ended March 31, 2022., based on exchange rate EUR/JPY 124.



Our Mission

Achieving a society in which the pursuit of happiness and a sustainable environment are harmonized free of conflict.

Our Vision

Energy that changes the future.

Our Will

Doing what humankind requires.

CEO's Message

The Panasonic Energy Co., Ltd. is globally active in our dry battery business that supports everyday convenience and comfort, as well as our B2B business such as industrial batteries and automotive batteries that support social infrastructure across a broad area.

For over 100 years we have been focusing on building a better world through electricity, providing solutions with our energy business centered on batteries to the social challenges of lifestyles in each era. Earnestly seeking to come to grips with the environmental issues confronting the world now and in the future, our quest continues under our mission of achieving a sustainable society harmonizing enriched lifestyles with the environment.

With this aim in mind, we are expanding our business rapidly and flexibly to adapt to the increasing complexity and diversity of this age of change, based on our

reservoir of technology development capabilities and high product quality. Buoyed by the powerful determination that we are doing what humankind requires to humanity to change the future, we are concentrating all our might to further evolve our technology, going beyond the standard concept of batteries to create a completely new type of value.

Business Details

Our business scope covers dry batteries supporting convenient, comfortable daily lives, as well as batteries supporting a broad range of social infrastructure and the automotive industry, including EVs. Our mission is to contribute to realizing sustainable societies harmonizing enriched lifestyles with care for the environment.

Sustainability



Environmental Management



Chemical Substances



Global Warming Prevention

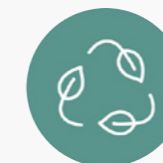

Resource Recycling



Environmental Communication

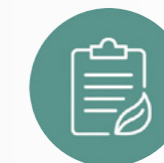

Environmental Performance

YOUR TOOLS TO FIND

At Panasonic Batteries we offer diverse services intended to make the customer's life easier. Find the right pictures and media files in our Mediapool, gain insight into battery technology in our manuals and white papers and be entertained by watching amazing videos at our YouTube Channel. Test our services!

New Mediapool

A media library, just as users expect it.

Extended content, additional functionalities - and as intuitive as never before: Panasonic Industry launches its new online library Mediapool - still for free and without registration.

For everyone being interested, buying, distributing or prototyping with products from one of the world's leading technology companies, Panasonic Industry's online library Mediapool has become a reliable address during the last years.

Now, the company has reworked the Mediapool from scratch in many regards: In addition to an ever growing set of images, videos, comprehensive datasheets, specific product brochures and catalogs, the library now also comprises detailed whitepapers or concise fighting cards. Furthermore, all those assets will be extended step by step to an ever wider field of industries, product groups or application purposes.

Next to the new and dynamic design - now containing teasers for immediately discovering new or relevant content - the entire navigation has been restructured and guarantees a straight, easy and intuitive user experience.

Any matching search result in the preview can be immediately downloaded via shopping cart - just as it is common practice in ordinary online stores. Additionally, things have been made even easier: If required, a media asset's URL now can be simply copied and shared.

Get a first idea of how to use the new Mediapool with our brief introduction video and download every file you need:

Watch introduction video

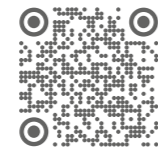

Use Mediapool directly

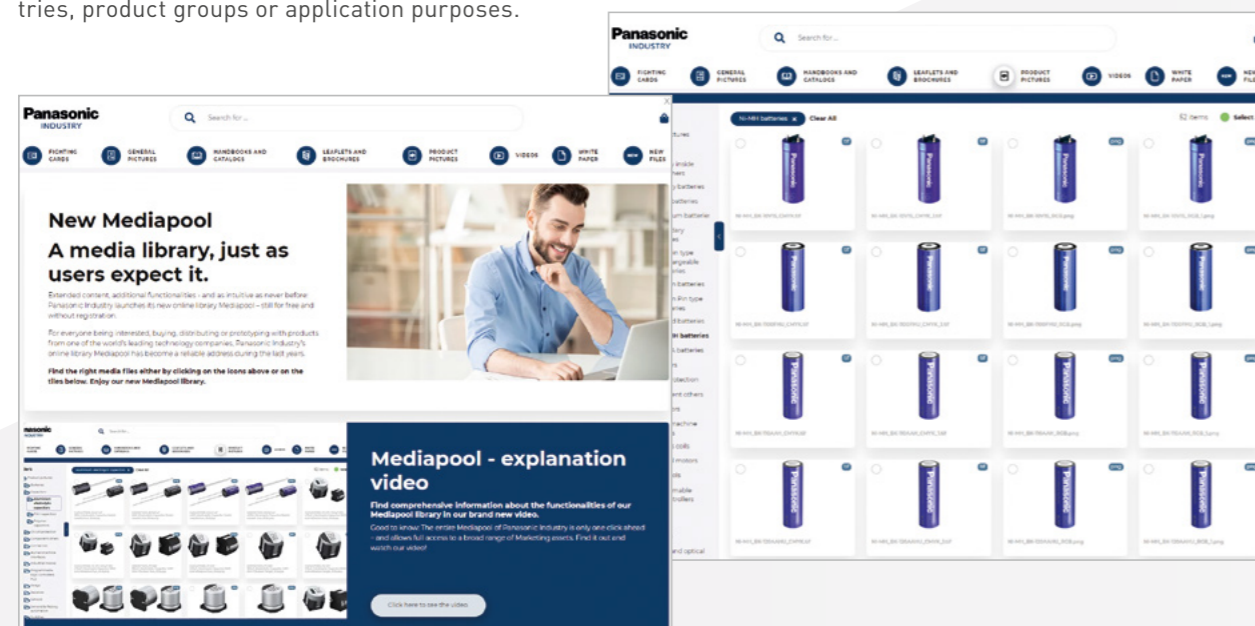
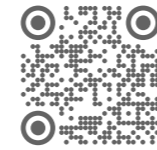

Manuals

Get the right product overview

Our range of digital tools to help you in your daily work are complemented by our 'classics' on paper: the Short Form Catalog and the technical manuals on the various battery product groups. These remain popular with customers as valuable reference aids.

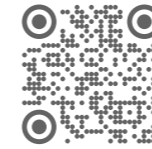

White Paper

Find the right technical information

Our white papers give developers and technical professionals the opportunity to leverage the expertise of our specialists for their own projects. We have been manufacturing batteries for a number of decades, and over this time have accumulated considerable knowledge and experience that we wish to share.

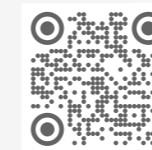

YouTube Channel

Find the right battery video

Please find a comprehensive selection of Panasonic battery videos at our YouTube channel. You can discover videos about the inner structure of our different battery chemistries, a couple of application videos and films which explain why batteries sometimes help to save human lives and sharks' lives as well. Are you getting curious? Please follow the QR code to our batteries video world!

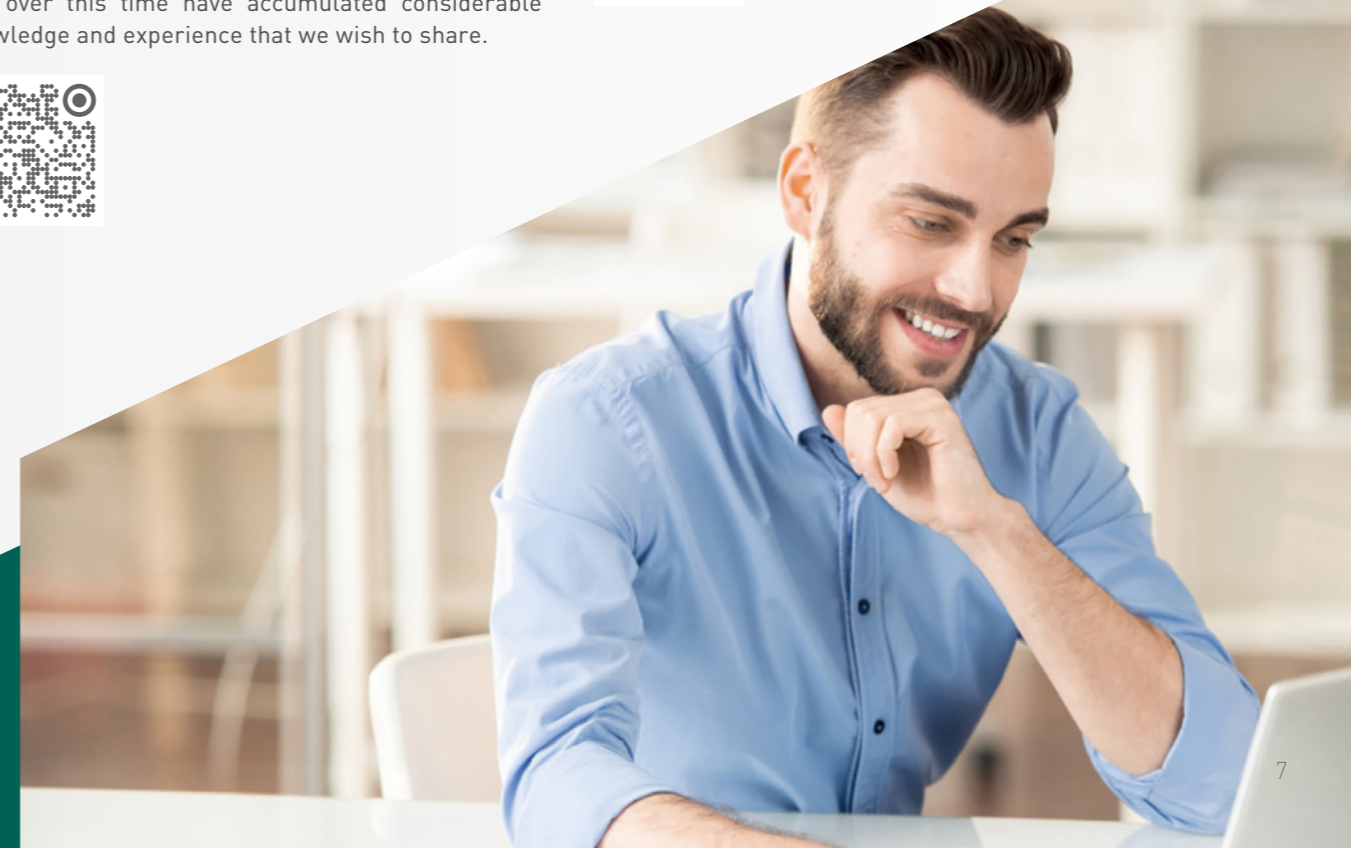

NICKEL-METAL HYDRIDE

Ideal for professional applications in challenging environment



Suitable for nearly every application
High quality and reliability
Good balance in terms of capacity and lifetime
Excellent discharge characteristics

Scan QR code to view product series video.



This product shows a product with sample labeling. The same applies to all illustrations of the Ni-MH batteries on the following pages.

STANDARD TYPE **N TYPE**

Ni-MH battery technology is nowadays the Ni-Cd (Nickel-Cadmium) successor technology for rechargeable and portable devices. These batteries are ideal for less complex and cost sensitive applications. For example medical equipment and handheld devices.

FEATURES

- High versatility for various application
- Good balance in terms of capacity and lifetime
- Various sizes for wide range of applications

APPLICATIONS

- Medical
- Communication
- Shaver
- Toothbrush
- Navigation device
- Torchlight
- Measurement
- Two way radio
- Construction sites signaling
- UPS, etc.

MODEL NUMBER (EXAMPLE)

BK - 7 0 A A

Diameter: AAA, AA, A
Multiply this by 10 to obtain the rated capacity (some exceptions)
Nickel-Metal Hydride battery

Model number	Size	Nominal voltage (V)	Discharge capacity (mAh)		Diameter (mm)	Total height (mm)	Weight (g)	Charging temperature (°C)	Discharging temperature (°C)
			Rated	Average					
BK-70AAAJ	AAA	1.2	700	730	10.5 +0/-0.7	44.5 +0/-1.5	12	0 to +45	-10 to +65
BK-70AA	AA	1.2	700	780	14.5 +0/-0.7	49.0 +0/-1.5	18	0 to +45	-10 to +65
BK-110AAO	AA	1.2	1,100	1,180	14.5 +0/-0.7	50.5 +0/-1.5	24	0 to +45	-10 to +65
BK-150AA	AA	1.2	1,500	1,580	14.5 +0/-0.7	50.5 +0/-1.5	25	0 to +45	-10 to +65
BK-200AAP	AA	1.2	1,900	1,980	14.5 +0/-0.7	50.5 +0/-1.5	28	0 to +45	-10 to +65
BK-200A	4/5A	1.2	2,000	2,040	17.0 +0/-0.7	43.0 +0/-1.5	32	0 to +45	-10 to +65
BK-210A	A	1.2	2,100	2,200	17.0 +0/-0.7	50.0 +0/-2.0	36	0 to +45	-10 to +65
BK-250A	A	1.2	2,450	2,600	17.0 +0/-0.7	50.0 +0/-2.0	37	0 to +45	-10 to +65
BK-380A	L-A	1.2	3,700	3,800	17.0 +0/-0.7	67.0 +0/-2.0	53	0 to +45	-10 to +65
BK-450A	LFat/A	1.2	4,200	4,500	18.2 +0/-0.7	67.5 +0/-1.5	61	0 to +45	-10 to +65

BUTTON TOP TYPE **B TYPE**

The Panasonic button type batteries are compatible with dry batteries such as Alkaline and can be used up to 1,800 times based on IEC*1 standards. Besides they provide a high capacity level and a low self-discharge.

FEATURES

- Offers long charge / discharge cycle life, about 1,800 times
- Low self-discharge and long storage life (still have 90% capacity after storage for 1 year)
- Compatibility with Alkaline battery



APPLICATIONS

- Flash light
- Personal digital assistant
- Toothbrush
- Shaver
- Remote control, etc.

MODEL NUMBER (EXAMPLE)

BK - 80 A A A B

Cap shape: button top type
Diameter: AAA, AA
Multiply this by 10 to obtain the rated capacity (some exceptions)
Nickel-Metal Hydride battery

Model number	Size	Nominal voltage (V)	Discharge capacity (mAh)		Diameter (mm)	Total height (mm)	Weight (g)	Charging temperature (°C)	Discharging temperature (°C)
			Rated	Average					
BK-80AAAB*1	 AAA	1.2	750	780	10.5 +0/-0.7	44.5 +0/-1.0	12	0 to +45	-10 to +65
BK-200AAB*2	 AA	1.2	1,900	1,980	14.5 +0/-0.7	50.5 +0/-1.0	28	0 to +45	-10 to +65

*1 Compatible with consumer AAA size.

*2 Compatible with consumer AA size.

INFRASTRUCTURE STANDARD TYPE **H TYPE**

The expected life of these back-up batteries is about 4 to 6 years and therefore approximately twice the lifetime compared to standard Ni-MH batteries. In addition they are capable of delivering excellent charge characteristics at high temperature (60°C). Recommended applications are for example emergency light, solar application and back-up for base station.

FEATURES

- Enables use in wide range of temperatures (-10 to +60)
- Small size with long operational life (4-6 years)







APPLICATIONS

- Medical equipment
- Emergency lighting
- POS system
- Solar window shutter
- Shaver, etc.

MODEL NUMBER (EXAMPLE)

BK - 70 A A H

Infrastructure for standard
Diameter: AAA, AA, A, F
Multiply this by 10 to obtain the rated capacity (some exceptions)
Nickel-Metal Hydride battery

Model number	Size	Nominal voltage (V)	Discharge capacity (mAh)		Diameter (mm)	Total height (mm)	Weight (g)	Charging temperature (°C)	Discharging temperature (°C)
			Rated	Average					
BK-70AAH	 AA	1.2	700	750	14.5 +0/-0.7	49.0 +0/-1.5	18	-10 to +60	-10 to +60
BK-110AAH	 AA	1.2	1,100	1,180	14.5 +0/-0.7	50.5 +0/-1.5	24	-10 to +60	-10 to +60
BK-150AAH	 AA	1.2	1,450	1,530	14.5 +0/-0.7	50.5 +0/-1.5	25	-10 to +60	-10 to +60
BK-160AH	 4/5A	1.2	1,600	1,720	17.0 +0/-0.7	43.0 +0/-1.5	29	-10 to +60	-10 to +60
BK-210AH	 A	1.2	1,900	2,050	17.0 +0/-0.7	50.0 +0/-2.0	35	-10 to +60	-10 to +60
BK-370AH	 LFat/A	1.2	3,500	3,700	18.2 +0/-0.7	67.5 +0/-1.5	60	-10 to +60	-10 to +60



HIGH RATE DISCHARGE & HIGH TEMPERATURE TYPE PH TYPE

These state-of-the-art back-up batteries deliver excellent current discharge characteristics at high temperature (60°C). They are able to power applications such as back-up for UPS, POS systems and solar window shutter.

FEATURES

- Long 4-6 years operational life
- High rate discharge (5lt discharge@20°C) available



MODEL NUMBER (EXAMPLE)

BK - 330 A PH

Infrastructure for high rate discharge
Diameter: A, SC
Multiply this by 10 to obtain the rated capacity
(some exceptions)
Nickel-Metal Hydride battery

APPLICATIONS

- Medical equipment
- Garden tool
- Robot cleaner
- Electric vehicle
- UPS
- POS system
- Solar window shutter, etc.

Model number	Size	Nominal voltage (V)	Discharge capacity (mAh)		Diameter (mm)	Total height (mm)	Weight (g)	Charging temperature (°C)	Discharging temperature (°C)
			Rated	Average					
BK-250SCH 	SC	1.2	2,500	2,650	23.0 +0/-1.0	43.0 +0/-1.5	53	-10 to +60	-10 to +60
BK-330APH 	LFat/A	1.2	3,200	3,300	18.2 +0/-0.7	67.5 +0/-1.5	59	-10 to +60	-10 to +60

HIGH RATE DISCHARGE & RAPID CHARGE TYPE P TYPE

These battery types provide excellent current discharge characteristics and are designed for rapid charging. They are most suitable for power tools, robot cleaners and high power high cycle applications.

FEATURES

- Excellent large current discharge characteristics
- Rapid charge-capable



MODEL NUMBER (EXAMPLE)

BK - 300 SCP

High rate discharge & rapid charge type
Diameter: SC
Multiply this by 10 to obtain the rated capacity
(some exceptions)
Nickel-Metal Hydride battery

APPLICATIONS

- Medical equipment
- Power tool
- Garden tool
- Robot cleaner
- Electric vehicle, etc.

Model number	Size	Nominal voltage (V)	Discharge capacity (mAh)		Diameter (mm)	Total height (mm)	Weight (g)	Charging temperature (°C)	Discharging temperature (°C)
			Rated	Average					
BK-260SCP*1 	SC	1.2	2,450	2,700	23.0 +0/-1.0	43.0 +0/-1.5	55	0 to +45	-10 to +65
BK-300SCP*1 	SC	1.2	2,800	3,050	23.0 +0/-1.0	43.0 +0/-1.5	57	0 to +45	-10 to +65

*1 For high power use application such as power tools.



INFRASTRUCTURE FOR LONG LIFE TYPE **U TYPE**

These very tough Ni-MH batteries offer a very long service life when using intermittent charging at high ambient temperature conditions. Moreover, these batteries are ideal as a replacement for standard Ni-Cd batteries. They are recommended for use in applications such as emergency lighting, servers, elevators, automated teller machines (ATM), solar powered devices and as a back-up for base stations.

FEATURES

- Expected lifetime is about 8 to 10 years
- Superior charge efficiency under high temperature conditions
- Available in various sizes
- Very long service life when using intermittent charging at high ambient temperature conditions
- Excellent low self discharge characteristics

MODEL NUMBER (EXAMPLE)

BK-1100FHU

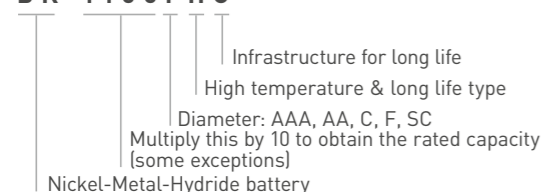

Model number	Size	Nominal voltage (V)	Discharge capacity (mAh)		Diameter (mm)	Total height (mm)	Weight (g)	Charging temperature (°C)	Discharging temperature (°C)
			Rated	Average					
BK-60AAAHU	AAA	1.2	500	550	10.5 +0/-0.7	44.5 +0/-1.5	12	-10 to +75	-20 to +75
BK-120AAHU	AA	1.2	1,200	1,280	14.5 +0/-0.7	50.5 +0/-1.5	24	-20 to +75	-20 to +75
BK-220SCHU	SC	1.2	2,200	2,350	23.0 +0/-1.0	43.0 +0/-1.5	50	-20 to +75	-20 to +75
BK-310CHU	C	1.2	3,100	3,300	25.8 +0/-1.0	50.0 +0/-2.0	80	-20 to +75	-20 to +75
BK-1100FHU	F	1.2	11,000	12,000	33.0 +0/-1.0	91.0 +0/-2.5	250	-20 to +75	-20 to +85

APPLICATIONS

- Solar powered application
- Server
- UPS system
- Elevator
- Emergency light, etc.

AUTOMOTIVE BACKUP TYPE **W TYPE**

This new Panasonic Ni-MH battery series is particularly designed for e-call systems. The long life reliability and the high discharge capability make these batteries ideal for these demanding applications. On the top our new batteries are eco-friendly designed and non-flammable.

FEATURES

- Excellent low temperature discharge performance
- Provides high safety battery pack
- Complies with automotive standard production (IATF, VDA6.3)

APPLICATIONS

- E-call
- ADAS back-up
- Low temperature data logger

MODEL NUMBER (EXAMPLE)

BK-60AAAWS

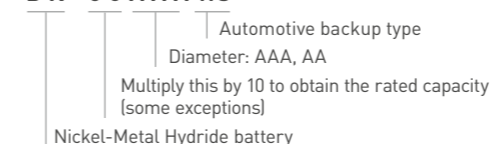

Model number	Size	Nominal voltage (V)	Discharge capacity (mAh)		Diameter (mm)	Total height (mm)	Weight (g)	Charging temperature (°C)	Discharging temperature (°C)
			Rated	Average					
BK-60AAAWS	AAA	1.2	500	550	10.5 +0/-0.7	44.5 +0/-1.5	11	-20 to +60	-30 to +85
BK-120AAWS	AA	1.2	1,100	1,180	14.5 +0/-0.7	50.5 +0/-1.5	24	-20 to +60	-40 to +85
BK-120AAWX	AA	1.2	1,100	1,180	14.5 +0/-0.7	50.5 +0/-1.5	24	-20 to +70	-40 to +105

BATTERY INSIDE*1

- 1 Exhaust gas hole
- 2 Safety vent
- 3 Insulation plate
- 4 Tube
- 5 Anode (hydrogen – absorbing alloy)
- 6 Separator
- 7 Cathode (Nickel Hydroxide)
- 8 Negative pole (cell can)
- 9 Positive pole
- 10 Top plate
- 11 Gasket
- 12 Collector



Scan QR code to view 3D animated video.



*1 The illustration shows only one example of Ni-MH battery structure.

LITHIUM-ION

Excellent battery safety and superior performance



Stable power supply with flat discharge voltage
 Excellent reliability
 Low self-discharge
 High energy density

Scan QR code to view product series video.



CYLINDRICAL SINGLE CELL

A perfect combination of high energy density (NNP technology), safety and long-life shows what is possible with Lithium-ion battery technology from Panasonic. Excellent battery safety on one hand, and superior battery performance on the other: this is what Panasonic stands for.

FEATURES

- High energy density and high voltage ensure small battery dimensions
- Long-life, stable power supply with flat discharge voltage
- Use of Lithium-ion batteries requires a safety unit
- Safety technologies such as HRL available

APPLICATIONS

- Power tool
- Garden tool
- UPS system
- Portable POS terminal
- GPS device
- Shaver
- E-bike
- Pedelec, etc.

MODEL NUMBER (EXAMPLE)

NCR-18650PF

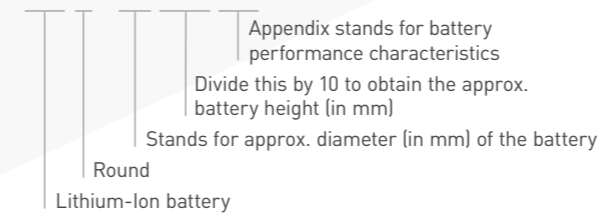

UR-18650RX

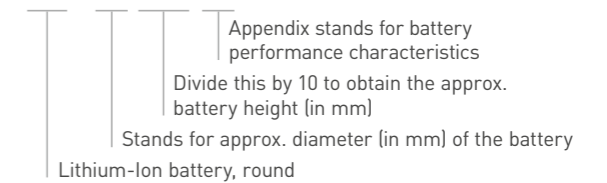

Model number	Technology	Nominal voltage (V)	Typical ¹⁾ capacity (mAh)	Size	Diameter (mm)	Total height (mm)	Weight (g)
NCR18500A	NNP ²⁾ , HRL ³⁾	3.6	2040	18500	18.5	49.36	33.5
NCR18500B	Li-Ion High capacity type	3.6	2350	18500	18.25	49.36	35.5
NCR18650BD	Li-Ion Long cycle type	3.6	3180	18650	18.25	65.10	48.5
NCR18650BF	NNP ²⁾ , HRL ³⁾	3.6	3350	18650	18.24	65.10	46.5
NCR18650GA	NNP ²⁾ , HRL ³⁾ , Li-Ion High power type	3.6	3450	18650	18.24	65.10	48.5
UR14500AC	Li-Ion Standard type	3.6	800	14500	13.90	49.20	18.6
UR14650R	Li-Ion High power type	3.6	1050	14650	13.90	64.80	26.6
UR18650A	Li-Ion Standard type	3.6	2250	18650	18.10	64.80	43.0
UR18650AA	Li-Ion Standard type	3.6	2250	18650	18.10	64.80	42.1

¹⁾ 4.20V charge ²⁾ NNP - Nickel Oxide Based New Platform ³⁾ HRL - Heat Resistance Layer

Model number	Technology	Nominal voltage (V)	Typical ^{*1} capacity (mAh)	Size	Diameter (mm)	Total height (mm)	Weight (g)
UR18650NSX	Li-Ion High power type	3.6	2600	18500	18.25	65.07	47.3
UR18650RX	Li-Ion High power type	3.6	2050	18650	18.24	65.10	46.5

BATTERY INSIDE*2

- 1 Exhaust gas hole
- 2 CID (Current Interrupt Device)
- 3 Insulator
- 4 Separator
- 5 Cathode
- 6 Anode
- 7 Negative pole (cell can)
- 8 Positive pole
- 9 PTC (Positive Temperature Coefficient Device)
- 10 Gasket
- 11 Collector



Scan QR code to view 3D animated video.

*1 4.20V charge

*2 Some batteries are not equipped with a PTC. Please consult Panasonic for further information. The illustration shows only one example of a Lithium-Ion battery structure.



PRISMATIC SINGLE CELL

A perfect combination of high energy density (NNP technology), safety and long-life shows what is possible with Lithium-Ion battery technology from Panasonic. Excellent battery safety on one hand, and superior battery performance on the other: this is what Panasonic stands for.

FEATURES

- High energy density and high voltage ensure small battery dimensions
- Long-life, stable power supply with flat discharge voltage
- Use of Lithium-Ion batteries requires a safety unit
- Safety technologies such as PSS and HRL available

APPLICATIONS

- Power tool
- Garden tool
- UPS system
- Portable POS terminal
- GPS device
- Shaver
- E-bike
- Pedelec, etc.

MODEL NUMBER (EXAMPLE)

NCA-752836A

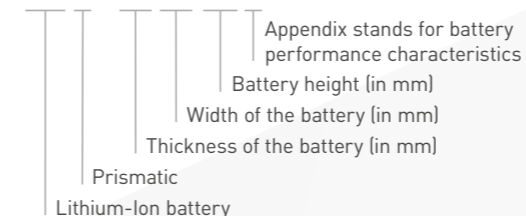

UF-103450P

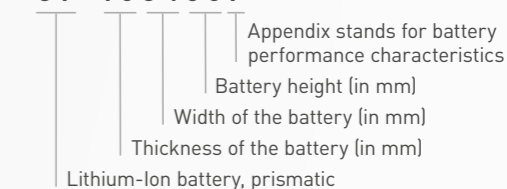

Model number	Technology	Nominal voltage (V)	Typical ^{*1} capacity (mAh)	Width (mm)	Thickness (mm)	Total height (mm)	Weight (g)
CGA103450A	Co system	3.7	1950	33.80	10.50	48.50	39.2
CGA463443XA	High voltage charge system	3.8	910	33.80	4.60	42.45	15.5
CGA463450XA	High voltage charge system	3.8	1030	33.80	4.55	49.45	17.6
CGA553450XA	High voltage charge system	3.8	1310	33.80	5.70	49.65	21.5
CGA573442	Co system	3.7	960	33.80	5.60	41.80	18.5
NCA103450	NNP ^{*2} , HRL ^{*3}	3.6	2350	33.80	10.50	48.50	38.3
NCA463436A	NNP ^{*2} , HRL ^{*3}	3.6	720	34.30	4.60	35.50	12.4
NCA523436	NNP ^{*2} , HRL ^{*3}	3.6	840	34.30	5.15	35.50	14.1
NCA572742SA	NNP ^{*2} , HRL ^{*3}	3.6	890	41.50	5.70	41.50	14.5

*1 4.20V charge *2 NNP - Nickel Oxide Based New Platform *3 HRL - Heat Resistance Layer

Model number	Technology	Nominal voltage (V)	Typical ^{*1} capacity (mAh)	Width (mm)	Thickness (mm)	Total height (mm)	Weight (g)
NCA573544	NNP ^{*2} , HRL ^{*3}	3.6	1190	34.60	5.80	44.0	19.9
NCA593446	NNP ^{*2} , HRL ^{*3}	3.6	1300	33.80	5.90	46.0	20.6
NCA596080SA	NNP ^{*2} , HRL ^{*3}	3.6	4530	60.0	5.95	79.95	68.0
NCA603134	NNP ^{*2} , HRL ^{*3}	3.6	730	31.10	6.60	34.45	13.7
NCA622944	NNP ^{*2} , HRL ^{*3}	3.6	1080	28.70	6.22	44.45	18.1
NCA622944SA	NNP ^{*2} , HRL ^{*3}	3.6	1170	28.70	6.22	44.45	18.0
NCA623535	NNP ^{*2} , HRL ^{*3}	3.6	1100	35.20	6.30	35.10	17.6
NCA653864	NNP ^{*2} , HRL ^{*3}	3.6	2200	38.10	6.50	64.35	36.6
NCA653864SA	NNP ^{*2} , HRL ^{*3}	3.6	2400	38.10	6.50	64.60	37.0
NCA673440	NNP ^{*2} , HRL ^{*3}	3.6	1265	33.80	6.75	40.35	20.3
NCA752836A	NNP ^{*2} , HRL ^{*3}	3.6	1010	27.90	7.80	35.70	16.7
NCA793540	NNP ^{*2} , HRL ^{*3}	3.6	1570	35.10	7.95	40.50	24.7
NCA843436	NNP ^{*2} , HRL ^{*3}	3.6	1300	33.90	8.70	35.70	23.0
NCA882936SA	NNP ^{*2} , HRL ^{*3}	3.6	1310	28.70	8.80	36.30	20.1
NCA903864A	NNP ^{*2} , HRL ^{*3}	3.6	3280	38.0	9.0	63.80	50.7
UF103450	LCO system ^{*1}	3.7	2000	33.80	10.50	48.80	38.5
UF463443	LCO system ^{*1}	3.7	850	33.85	4.55	42.60	16.0
UF463450	LCO system ^{*1}	3.7	960	33.85	4.45	49.60	18.5
UF553436	LCO system ^{*1}	3.7	830	33.85	5.50	35.60	15.6
UF553443	LCO system ^{*1}	3.7	1040	33.80	5.55	42.80	18.7

^{*1} 4.20V charge ^{*2} NNP - Nickel Oxide Based New Platform ^{*3} HRL - Heat Resistance Layer

Model number	Technology	Nominal voltage (V)	Typical ^{*1} capacity (mAh)	Width (mm)	Thickness (mm)	Total height (mm)	Weight (g)
UF553450	LCO system ^{*1}	3.7	1200	33.85	5.55	49.80	22.3
UF583136	LCO system ^{*4}	3.7	740	31.15	5.60	36.30	14.2
UF653450	LCO system ^{*4}	3.7	1300	33.85	6.35	49.80	25.1
UF673438	LCO system ^{*4}	3.7	1100	33.50	6.70	38.0	20.8
UF703450	LCO system ^{*4}	3.7	1480	33.85	7.0	49.80	28.1

BATTERY INSIDE*2

- 1 Anti-explosion valve
- 2 Anode cap
- 3 Terminal
- 4 Internal terminal
- 5 Lead
- 6 Cathode
- 7 Separator
- 8 Anode
- 9 Case
- 10 (Upper) Gasket
- 11 Sealing tap
- 12 (Lower) Gasket
- 13 Insulation frame body



NOTICE TO READERS



We are unable to support single cell business or accept orders from consumers. We design Lithium-Ion battery packs including a suitable safety unit device based on the technical specification of the customer. Due to the need for careful review when selecting Lithium-Ion battery solutions please contact your local Panasonic sales office. In order to avoid a lack of supply please check the battery availability with your Panasonic sales team before design-in. Moreover this all Panasonic Lithium-Ion cells must always be equipped with a safety unit.

^{*1} LCO system - This Panasonic system uses a Cobalt-based cathode and offers high capacity. Some batteries are not equipped with a PTC. Please consult Panasonic for further information.

^{*2} The illustration shows only one example of a Lithium-Ion battery structure.

LITHIUM-ION PIN TYPE

Miniature rechargeable batteries – especially designed for wearables



- Compact design
- Extremely light & robust
- Long-life
- Quick charging
- High reliability & safety

PIN TYPE

The industry's smallest-diameter cylindrical rechargeable battery has been developed using extremely fine components and materials compared to standard Lithium-Ion batteries. Its outstanding technical design makes this battery ideal for wearable devices with heavy power demands. Panasonic intends to expand this new battery line-up successively to meet the requirements of next-generation mobile communication devices.

FEATURES

- Quite small diameter pin-shaped Lithium-Ion battery which expands design options for micro devices
- Rechargeable battery that can be used repeatedly and has the output capability required for near field communications
- High-strength metal exterior provides excellent reliability

APPLICATIONS

- Electric pen
- Wearables
- Hearing aid
- Wristband devices
- Smart glasses
- Industrial IoT applications
- Fitness trackers, etc.

Model number	Technology	Nominal voltage (V)	Typical ^{*1} capacity (mAh)	Diameter (mm)	Total height (mm)	Weight (g)
CG320B ^{*2}	Co system	3.8	16	3.65	20	0.5
CG420A ^{*2}	Co system	3.8	23	4.7	20	0.8
CG420B ^{*2}	Co system	3.8	29	4.7	20	0.9
CG425A ^{*2}	Co system	3.8	32	4.7	25	1.0

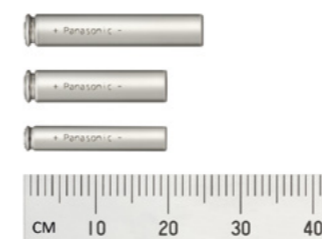

BATTERY INSIDE^{*3}

- 1 Positive electrode (Lithium Cobalt-Oxide)
- 2 Separator
- 3 Negative electrode (Graphite)

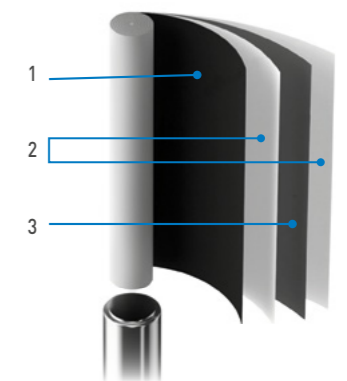

*1 4.35V charge

*2 This battery is supplied with tabs.

*3 The illustration shows only one example of a Lithium-Ion Pin Type battery structure.

LITHIUM

State-of-the-art Lithium batteries



Low self-discharge
Decades of mass production experience
Superior designed battery ranges
Proven reliability

Scan QR code
to view product
series video.

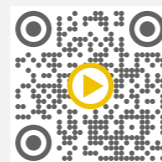

PRIMARY BR AND CR

These days Lithium battery technologies are getting more and more important. Due to their high voltage, low self-discharge and proven reliability a broad range of applications can be powered. In particular the chemistries BR, CR and ER battery technologies are leading the industries. Please study the comparison overview below and find out why Panasonic is especially emphasizing on its famous BR and CR technology which is a proof for outstanding quality for years in the market.

COMPARISON OF LITHIUM PRIMARY CHEMISTRY*1

Chemistry		BR	CR	ER	
Material	Cathode	CF	MnO ₂	SOCl ₂	
	Anode	Lithium metal	Lithium metal	Lithium metal	
	Electrolyte	Organic electrolyte	Organic electrolyte	Organic electrolyte	
Nominal voltage		3V	3V	3.6V	
Performance	Voltage during discharge (Initial)	Low current	+	+	+
		High current	+	++	-
Performance	Voltage during discharge (End of capacity)	Low current	++	++	++
		High current	+	++	-
Performance	Pulse performance at low temperature	Initial	+	++	-
		End of life	+	++	-
Storage performance		++	+	- ²	
Reliability		++	+	- ²	
Safety		++	++	-	
Environment	Eco friendly	++	++	- ³	

++ Very good applicability
+ Good applicability
- Not good applicability

*1 Please contact Panasonic to get more detailed information about this technical comparison overview.

*2 Impedance increasing due to the passivation phenomena.

*3 Harmful substances included.

LITHIUM BR CYLINDRICAL SERIES (NON-RECHARGEABLE)

Our Panasonic Poly-Carbonmonofluoride Lithium batteries (BR series) are ideal for applications such as meters or smoke detectors which demand either long-term power supply reliability or need to handle a wide temperature range.

FEATURES

- Operating temperature range: between -40°C ~ +85°C
- Self-discharge rate at 20°C is just 0.5% per year
- Superior long-term reliability
- 38+ years of experience in production

APPLICATIONS

- Heat cost allocators
- Water & gas meters
- Car alarm
- Smoke detectors
- Tracking & RFID
- Marine devices, etc.

MODEL NUMBER (EXAMPLE)

BR - 1 / 2 A A

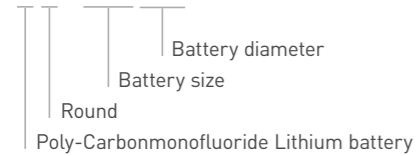

Model number	Nominal voltage (V)	Nominal ¹ capacity (mAh)	Size	Diameter (mm)	Total height (mm)	Weight (g)	Discharging temperature (°C)
BR-1/2AA ^{2,3}	3	1,000	1/2 AA	14.5	25.5	8	-40 to +100
BR-2/3A ³	3	1,200	2/3 A 17355	17.0	33.5	13	-40 to +85
BR-2/3AG ³	3	1,450	2/3 A 17355	17.0	33.5	13	-40 to +85
BR-A ³	3	1,800	A	17.0	45.5	18	-40 to +85
BR-AG ³	3	2,200	A	17.0	45.5	18	-40 to +85
BR-C ³	3	5,000	C	26.0	50.5	41	-40 to +85

*1 Capacity based on standard drain and cut off voltage down to 2.0V at 20°C.

*2 Operating temperature range is from -40°C ~ +100°C.

*3 Cells are supplied with tabs or lead-wires only. For available configurations please consult the Panasonic homepage or your sales contact.

BATTERY INSIDE*1

- 1 Positive pole
- 2 Gasket
- 3 Separator
- 4 Cathode (Carbonmonofluoride)
- 5 Anode (Lithium)
- 6 Insulator
- 7 Tube
- 8 Positive pole platform
- 9 Cell can
- 10 Collector
- 11 Negative pole



Scan QR code to view 3D animated video.

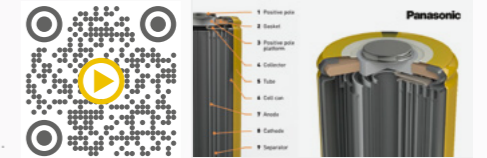

LITHIUM CR CYLINDRICAL SERIES (NON-RECHARGEABLE)

Panasonic Lithium CR type cylindrical batteries come as either single cells or dual cell packs. All cylindrical type Manganese Dioxide (CR series) Lithium batteries feature a spiral structure. With the enlarged electrode surface areas, they permit a current as high as several amperes to be drawn. In addition these batteries are convenient for equipments which are considered to replace the battery at the field.

FEATURES

- Operating temperature range: between -40°C ~ +70°C*2
- Good pulse discharge capability
- Stable operation voltage
- Self-discharge rate at 20°C just 1% per year

APPLICATIONS

- Medical equipment
- Door lock systems
- Marine devices
- Cameras
- High energy flashlights
- Sanitary equipment, etc.



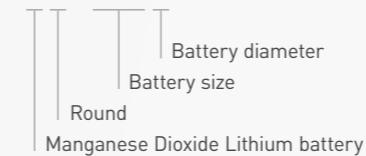

MODEL NUMBER (EXAMPLE)

CR - 1 2 3 A



*1 The illustration shows only one example of Lithium battery structure.

*2 Please consult your Panasonic sales representative when anticipating usage in operation temperature is between -40°C to -20°C.

Model number		Nominal voltage (V)	Nominal ¹ capacity (mAh)	Size	Diameter (mm)	Total height (mm)	Weight (g)	Discharging temperature (°C)
CR-2 ²		3	850	15270	15.6	27.0	11	-40 to +70
CR-123A ²		3	1,550	17345	17.0	34.5	16	-40 to +70
2CR-5 ²		6	1,550	-	34.0 x 17.0	45.0	38	-40 to +70
CR-P2 ²		6	1,550	-	35.0 x 19.5	36.0	37	-40 to +70

BATTERY INSIDE*³

- 1 Positive pole
- 2 Vent diaphragm
- 3 Gasket
- 4 Separator
- 5 Anode (Lithium)
- 6 Cathode (Manganese Dioxide)
- 7 Tube
- 8 Insulator
- 9 PTC (Positive Temperature Coefficient Device)
- 10 Collector
- 11 Cell can
- 12 Negative pole



*¹ Capacity based on standard drain and cut off voltage down to 2.0V or 4.0V at 20°C.

*² Please consult your Panasonic sales representative when anticipating usage in operation temperature is between -40°C to -20°C, or +60°C to +70°C.

*³ The illustration shows only one example of Lithium battery structure.

LITHIUM CR CYLINDRICAL SERIES FOR INDUSTRIAL (NON-RECHARGEABLE)

Ideal for industrial equipment, this series offers both excellent high-rate discharge performance and a service life of 15 years or more.

FEATURES

- Stable impedance throughout battery life
- Operating temperature range: between -40°C ~ +85°C*¹
- Superior high drain discharge performance
- Long-term reliability
- Self-discharge rate at 20°C is just 1% per year

APPLICATIONS

- Medical equipment
- Automotive
- Smoke detectors
- Security devices and systems
- Marine devices
- Smart meter, etc.

MODEL NUMBER (EXAMPLE)

CR - 2 / 3 A Z

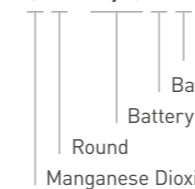

 CR - 2 / 3 A Z

- CR: Manganese Dioxide Lithium battery
- 2: Battery size
- 3: Battery diameter
- AZ: Stands for battery performance characteristics

Model number		Nominal voltage (V)	Nominal ² capacity (mAh)	Size	Diameter (mm)	Total height (mm)	Weight (g)	Discharging temperature (°C)
CR-AAK		3	1,650	AA 14500	14.5	50.5	18	-40 to +85
CR-AAU		3	1,800	AA 14500	14.5	50.5	18	-40 to +85
CR-2Z		3	1,000	15270	15.6	27.0	11	-40 to +85
CR-2U		3	1,000	15270	15.6	27.0	11	-40 to +85
CR-2/3AU		3	1,600	2/3A 17335	17.0	33.5	16	-40 to +85
CR-2/3AZ		3	1,600	2/3A 17335	17.0	33.5	16	-40 to +85
CR-AG		3	2,400	A	17.0	45.5	22	-40 to +85
CR-AGZ		3	2,700	A	17.0	45.5	23	-40 to +85

*¹ Please contact Panasonic when anticipating usage in operation temperature 70°C or above.

*² Capacity based on standard drain and cut off voltage down to 2.0V at 20°C.

BATTERY INSIDE*1

- 1 Positive pole
- 2 Vent diaphragm
- 3 Tube
- 4 Anode (Lithium)
- 5 Separator
- 6 Cathode (Manganese Dioxide)
- 7 Insulator
- 8 PTC (Positive Temperature Coefficient Device)
- 9 Collector
- 10 Cell can
- 11 Negative pole



*1 The illustration shows only one example of Lithium battery structure.

LITHIUM BR COIN SERIES (NON-RECHARGEABLE)

Panasonic Lithium BR coin type batteries feature high energy density, and were developed and commercialized using Panasonic's extensive experience in battery technology. They exhibit stable performance under high ambient temperatures.

FEATURES

- Self-discharge rate at 20°C is just 1.0% per year
- Wide operating temperature range: between -30°C ~ +85°C
- Superior long-term reliability
- 42+ years of experience in production

APPLICATIONS

- Tracking & RFID
- Memory back-up
- Real Time Clock (RTC)
- Meters, etc.

MODEL NUMBER (EXAMPLE)

BR - 2 3 3 0

Divide this by 10 to obtain the battery height in mm
Battery diameter (in mm)
Round
Poly-Carbonmonofluoride Lithium battery

Model number	Nominal voltage (V)	Nominal ¹ capacity (mAh)	Diameter (mm)	Total height (mm)	Weight (g)	Discharging temperature (°C)
BR-1220	3	35	12.5	2.0	0.7	-30 to +85
BR-1225	3	48	12.5	2.5	0.8	-30 to +85
BR-1632	3	120	16.0	3.2	1.5	-30 to +85
BR-2032	3	200	20.0	3.2	2.6	-30 to +85
BR-2325	3	165	23.0	2.5	3.0	-30 to +85
BR-2330	3	255	23.0	3.0	3.2	-30 to +85
BR-3032	3	500	30.0	3.2	5.7	-30 to +85

BATTERY INSIDE*2

- 1 Negative pole
- 2 Anode (Lithium)
- 3 Separator
- 4 Gasket
- 5 Positive pole (cell can)
- 6 Cathode (Poly-Carbonmonofluoride)

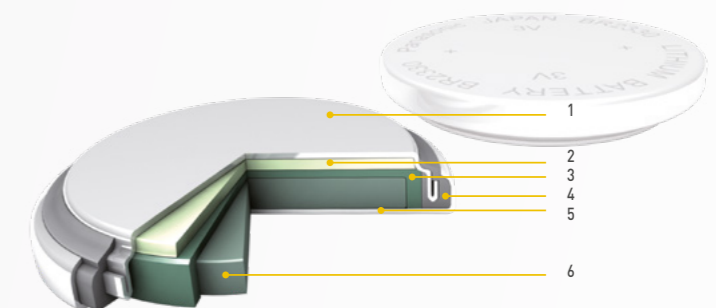

*1 Based on standard drain and cut off voltage down to 2.0V at 20°C.

*2 The illustration shows only one example of Lithium battery structure.

LITHIUM BR-A SERIES COIN TYPE FOR HIGH TEMPERATURE USAGE

(NON-RECHARGEABLE)

The high energy density and the special material for gasket and separator make this battery series the ideal power supply in high ambient temperature applications.

FEATURES

- Superior design for high temperature applications -40°C ~ +125°C
- Outstanding long-term reliability
- 22+ years of experience in production
- Self-discharge rate at 20°C is just 0.5% per year

APPLICATIONS

- Tire Pressure Monitoring Systems (TPMS)
- Electric Toll Collection (ETC)
- Heat cost allocators, etc.

MODEL NUMBER (EXAMPLE)

BR - 2 4 7 7 A

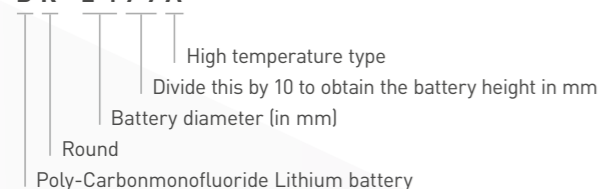

Model number	Nominal voltage (V)	Nominal ¹ capacity (mAh)	Diameter (mm)	Total height (mm)	Weight (g)	Discharging temperature (°C)
BR-1225A	3	48	12.5	2.5	0.8	-40 to +125
BR-1632A ²	3	120	16.0	3.2	1.5	-40 to +125
BR-2330A ²	3	255	23.0	3.0	3.2	-40 to +125
BR-2450A ²	3	550	24.5	5.9	4.9	-40 to +125
BR-2477A ²	3	1,000	24.5	7.7	7.9	-40 to +125

*1 Based on standard drain and cut off voltage down to 2.0V at 20°C.

*2 Cells are supplied with tabs or lead-wires only. For available configurations please consult the Panasonic homepage or yoursales contact.

BATTERY INSIDE*1

- 1 Negative pole
- 2 Anode (Lithium)
- 3 Separator
- 4 Gasket
- 5 Positive pole (cell can)
- 6 Cathode (Poly-Carbonmonofluoride)

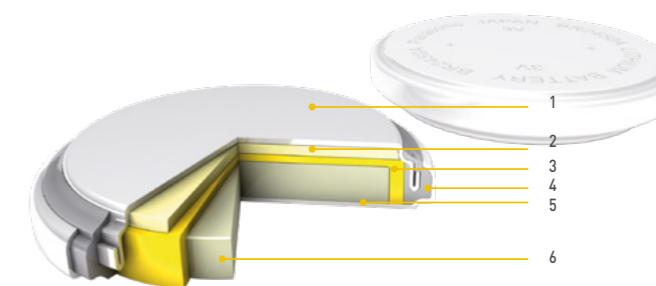

LITHIUM CR COIN MANGANESE DIOXIDE SERIES (NON-RECHARGEABLE)

These batteries have a proven track record of excellence in equipment requiring high currents. Additionally Panasonic has many years of manufacturing experience with this battery technology.

FEATURES

- Good pulse capability
- Stable voltage level during discharge
- Long-term reliability
- Self-discharge rate at 20°C is just 1.0% per year
- Temperature range -30°C ~ +85°C*2

APPLICATIONS

- Remote Keyless Entry (RKE)
- Electricity meters
- Medical equipment
- Tracking & RFID
- Vending machines
- Price tags, etc.

MODEL NUMBER (EXAMPLE)

CR - 2 0 3 2

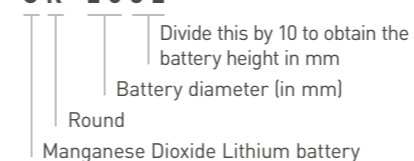

Model number	Nominal voltage (V)	Nominal ³ capacity (mAh)	Diameter (mm)	Total height (mm)	Weight (g)	Discharging temperature (°C)
CR-1025	3	30	10.0	2.5	0.6	-30 to +85
CR-1216	3	25	12.5	1.6	0.7	-30 to +85
CR-1220	3	35	12.5	2.0	0.9	-30 to +85
CR-1616	3	55	16.0	1.6	1.0	-30 to +85
CR-1620	3	75	16.0	2.0	1.3	-30 to +85

*1 The illustration shows only one example of Lithium battery structure.

*2 Please contact Panasonic when anticipating usage in operation temperature 70°C or above.

*3 Based on standard drain and cut off voltage down to 2.0V at 20°C.



Model number	Nominal voltage (V)	Nominal ¹ capacity (mAh)	Diameter (mm)	Total height (mm)	Weight (g)	Discharging temperature (°C)
CR-1632	3	140	16.0	3.2	1.9	-30 to +85
CR-2012	3	55	20.0	1.2	1.4	-30 to +85
CR-2016	3	90	20.0	1.6	1.6	-30 to +85
CR-2025	3	165	20.0	2.5	2.3	-30 to +85
CR-2032	3	225	20.0	3.2	2.8	-30 to +85
CR-2330	3	265	23.0	3.0	3.7	-30 to +85
CR-2354	3	560	23.0	5.4	5.7	-30 to +85
CR-2412	3	100	24.5	1.2	2.0	-30 to +85
CR-2450	3	620	24.5	5.0	6.2	-30 to +85
CR-2477	3	1,000	24.5	7.7	10.5	-30 to +85
CR-3032	3	500	30.0	3.2	6.9	-30 to +85

BATTERY INSIDE*2

- 1 Negative pole
- 2 Anode (Lithium)
- 3 Separator
- 4 Gasket
- 5 Positive pole (cell can)
- 6 Cathode (Manganese Dioxide)

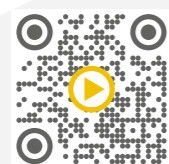
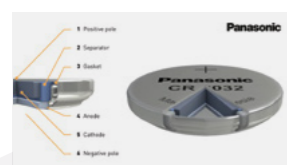
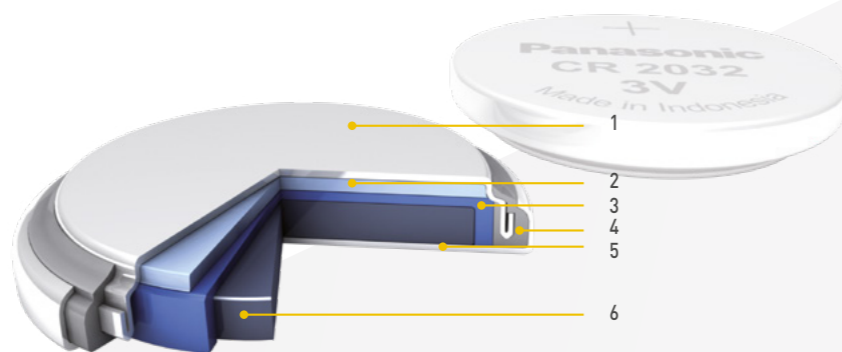

Scan QR code to view 3D animated video.

*1 Based on standard drain and cut off voltage down to 2.0V at 20°C.

*2 The illustration shows only one example of Lithium battery structure.

LITHIUM CR-A/B COIN HIGH TEMPERATURE MANGANESE DIOXIDE SERIES (NON-RECHARGEABLE)

Comprising key design elements of the BR-A high temperature series in combination with the benefits of the conventional CR coin series, these batteries offer the best of both worlds in a cost effective manner.

FEATURES

- Excellent durability in high temperature (up to 125°C*1) allows various devices such as automotive electrical components and outdoor devices to be used under severe environments
- Superior pulse discharging characteristics even at low temperatures and can be used in a wide operating temperature
- Excellent long-term reliability enables safe and long-term use

APPLICATIONS

- Tire Pressure Monitoring Systems (TPMS)
- Electronic Toll Collection (ETC)
- Connected meters, etc.

MODEL NUMBER (EXAMPLE)

C R - 20 32 A (or B)

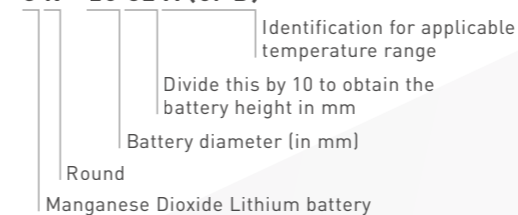

Model number ¹	Nominal voltage (V)	Nominal ² capacity (mAh)	Diameter (mm)	Total height (mm)	Weight (g)	Discharging temperature (°C)
CR-2032A ³	3	210	20.0	3.2	3.0	-40 to +125
CR-2032B ³	3	210	20.0	3.2	3.0	-40 to +120
CR-2050A ³	3	345	20.0	5.0	4.1	-40 to +125
CR-2050B ³	3	345	20.0	5.0	4.1	-40 to +120
CR-2450B ³	3	560	24.5	5.0	6.2	-40 to +105

BATTERY INSIDE*4

- 1 Negative pole
- 2 Anode (Lithium)
- 3 Separator
- 4 Gasket
- 5 Positive pole (cell can)
- 6 Cathode (Manganese dioxide)

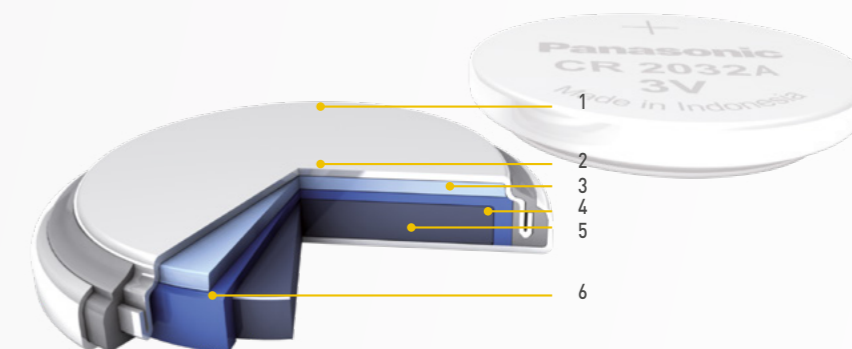

*1 Max. operating temperature +120°C for „B” and +125°C for „A” type models (dia 20mm), +105°C for CR-2450B.

*2 Based on standard drain and cut off voltage down to 2.0V at 20°C.

*3 Cells are supplied with tabs or lead-wires only. For available configurations please consult the Panasonic homepage or your sales contact.

*4 The illustration shows only one example of Lithium battery structure.

LITHIUM VL, ML, MT COIN SERIES (RECHARGEABLE)

These Panasonic rechargeable Lithium coin batteries are designed chiefly for memory back-up applications. Their voltage ranges from 1.5V to 3V.

FEATURES

- Rechargeable Lithium technology
- Self-discharge rate at 20°C is only 2.0% per year for VL and ML battery types
- 1,000 charge-discharge cycles for VL and ML at 10% depth of discharge
- Superior long-term reliability
- Years of experience in production

APPLICATIONS

- Computers
- Remote Keyless Entry (RKE)
- Fax machines
- Mobile phones
- Watches, etc.

MODEL NUMBER (EXAMPLE)

VL-2020

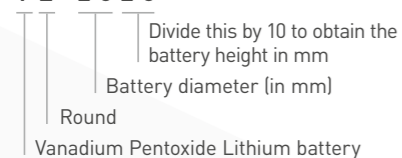

COIN VANADIUM PENTOXIDE LITHIUM (VL SERIES)

Model number	Nominal voltage (V)	Nominal ^{*1} capacity (mAh)	Diameter (mm)	Total height (mm)	Weight (g)	Discharging temperature (°C)
VL-1220 ^{*2}	3	7	12.5	2.0	0.8	-20 to +60
VL-2020 ^{*2}	3	20	20.0	2.0	2.1	-20 to +60
VL-2330 ^{*2}	3	50	23.0	3.0	3.5	-20 to +60
VL-3032 ^{*2}	3	100	30.0	3.2	6.3	-20 to +60

^{*1} Based on standard drain and cut off voltage down to 2.0V at 20°C. State-of-Charge ex-factory: ~70%.

^{*2} Cells are supplied with tabs or lead-wires only. For available configurations please consult the Panasonic homepage or your sales contact.

COIN MANGANESE LITHIUM (ML SERIES)

Model number	Nominal voltage (V)	Nominal ^{*1} capacity (mAh)	Diameter (mm)	Total height (mm)	Weight (g)	Discharging temperature (°C)
ML-2020	3	45	20.0	2.0	2.2	-20 to +60

COIN MANGANESE TITANIUM LITHIUM (MT SERIES)

Model number	Nominal voltage (V)	Nominal ^{*2} capacity (mAh)	Diameter (mm)	Total height (mm)	Weight (g)	Discharging temperature (°C)
MT-516	1.5	1.8	5.8	1.6	0.1	-10 to +60
MT-621	1.5	2.5	6.8	2.1	0.2	-10 to +60
MT-920	1.5	5	9.5	2.0	0.4	-10 to +60

BATTERY INSIDE^{*3}

- 1 Negative pole
- 2 Anode (Lithium Aluminium alloy)
- 3 Separator
- 4 Gasket
- 5 Positive pole (cell can)
- 6 Cathode (Vanadium Pentoxide)

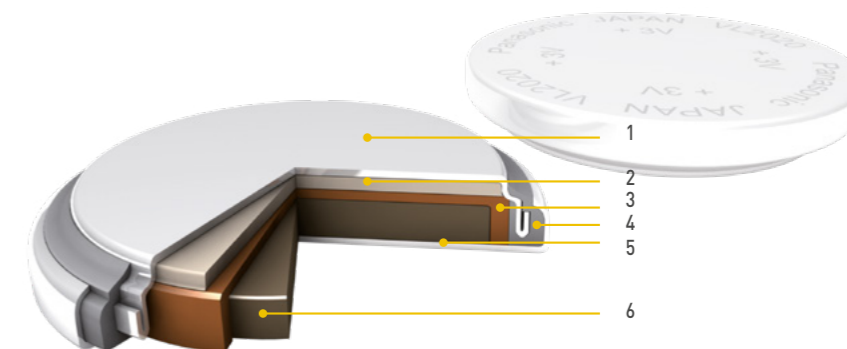

^{*1} Based on standard drain and cut off voltage down to 2.0V at 20°C. State-of-Charge ex-factory: ~70%.

^{*2} Based on standard drain and cut off voltage down to 0.5V at 20°C. State-of-Charge ex-factory: ~70%

^{*3} The illustration shows only one example of Lithium battery structure.

PIN TYPE POLY-CARBONMONOFLUORIDE LITHIUM (BR SERIES)

(NON-RECHARGEABLE)



Panasonic offers a unique pin shape and space-saving design to meet the requirements of small-scale applications.

FEATURES

- Superior design for high temperature applications -30°C ~ +80°C
- Outstanding long-term reliability
- Years of experience in production
- Self-discharge rate at 20°C is just 0.5% per year

APPLICATIONS

- LED-type night fishing floats
- Various illumination products
- Fishing pole tip lights
- Toys, etc.

Model number	Nominal voltage (V)	Nominal ¹ capacity (mAh)	Diameter (mm)	Total height (mm)	Weight (g)	Discharging temperature (°C)
BR-425 	3	25	4.2	25.9	0.6	-30 to +80
BR-435 	3	50	4.2	35.9	0.9	-30 to +80

*1 Based on standard drain and cut off voltage down to 2.0V at 20°C.



TERMINAL TYPES

Panasonic offers a broad range of different tabs for our Lithium batteries in order to meet all customer needs. In addition tailormade solutions are possible as well.

F TYPE

Surface mount (short distance)

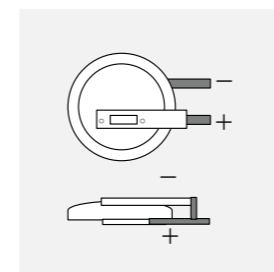

F TYPE

Surface mount (wide distance)

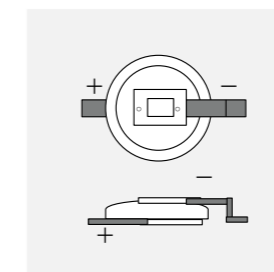

G TYPE

Through hole horizontal mount (normal distance)

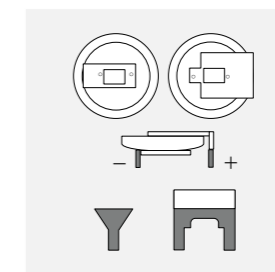

G TYPE

Through hole horizontal mount (short distance)

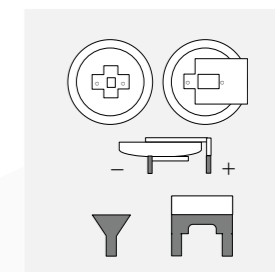

G TYPE

Through hole horizontal mount (wide distance)

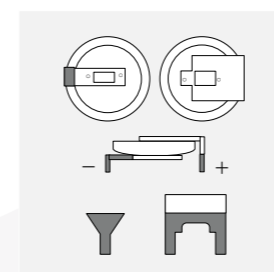

H TYPE

Through hole horizontal mount (normal distance)

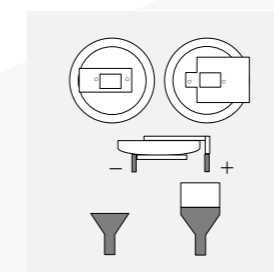

H TYPE

Through hole horizontal mount (short distance)

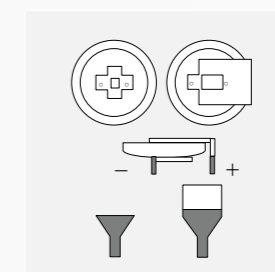

H TYPE

Through hole horizontal mount (wide distance)

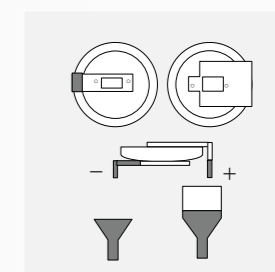

V TYPE

Through hole vertical mount (two pins)

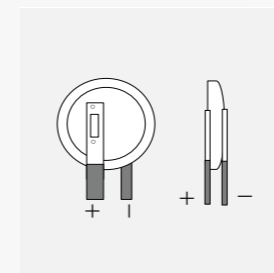

W TYPE

Through hole vertical mount (three pins)

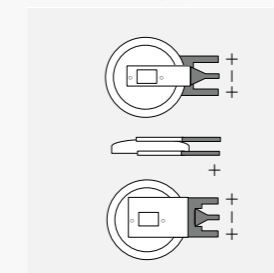

LEAD WIRE TYPE

Coin cell

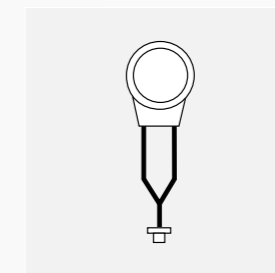

LEAD WIRE TYPE

Single cylindrical cell

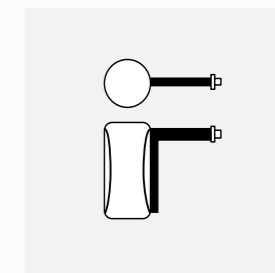

LEAD WIRE TYPE

2 to 6 cells of cylindrical batteries in parallel or in series

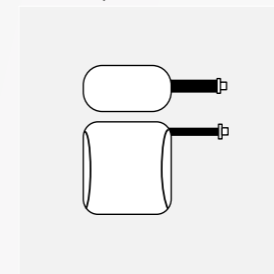

TAB TERMINAL

Cylindrical batteries for through hole mounting

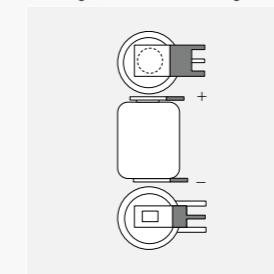

TAB TERMINAL

Cylindrical batteries for lead wire attaching

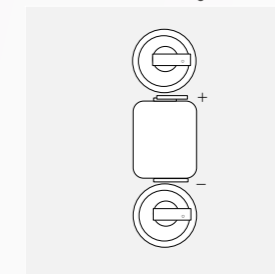

TAB TERMINAL

Cylindrical batteries for hanging on PCB (hook type)

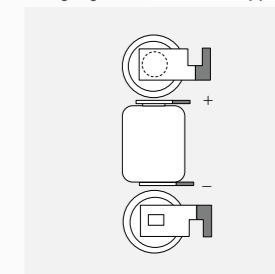

ALKALINE

Ideal for high-performance standard applications



- High and medium drain applications
- Continuously reliable energy provision
- Long shelf life
- Superior low temperature behavior

Scan QR code to view product series video.



ALKALINE





Panasonic Alkaline batteries are made from the same basic materials as Zinc-Carbon batteries, but deliver generally higher performance on all criteria. These batteries can therefore power high-performance standard applications. Our Alkaline batteries are mostly made in Europe and fulfill the highest quality standards.

FEATURES

- Developed for high and medium drain appliances
- Continuously reliable energy provision
- Long shelf life
- Excellent leakage resistance
- Superior low temperature behavior

APPLICATIONS

- Smoke detectors
- Marine devices
- High energy flashlights
- Scales
- Cleaning and hygiene services
- Gas barbecue igniter
- Suitcase electronic pass, etc.

Model number		Size	Nominal voltage (V)	Diameter (mm)	Total height (mm)	Weight (g)	IEC
LR03AD		AAA	1.5	10.5	44.5	11	LR03
LR6AD		AA	1.5	14.5	50.5	22	LR6
LR14AD		C	1.5	26.2	50.0	66	LR14
LR20AD		D	1.5	34.2	61.5	138	LR20
6LR61AD		9V	9	26.5 x 17.5	48.5	43	6LR61



FIND THE RIGHT CONTACT



Ihr Panasonic Distributor

Elblinger Elektronik GmbH

Lange Wanne 25

38259 Salzgitter

Tel. 05341 / 8212-1

Fax 05341 / 8212-99

mail@elblinger-elektronik.de

www.elblinger-elektronik.de

Panasonic
ENERGY